

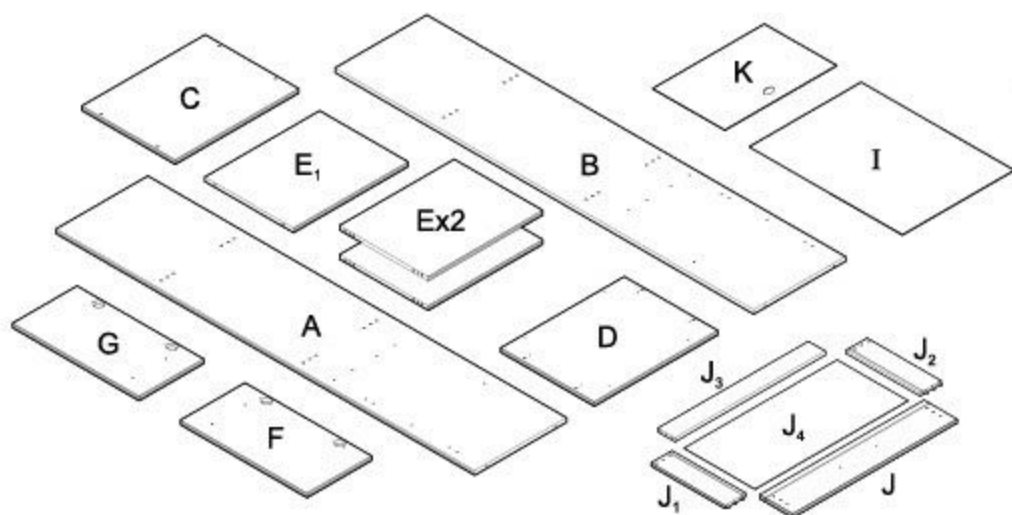

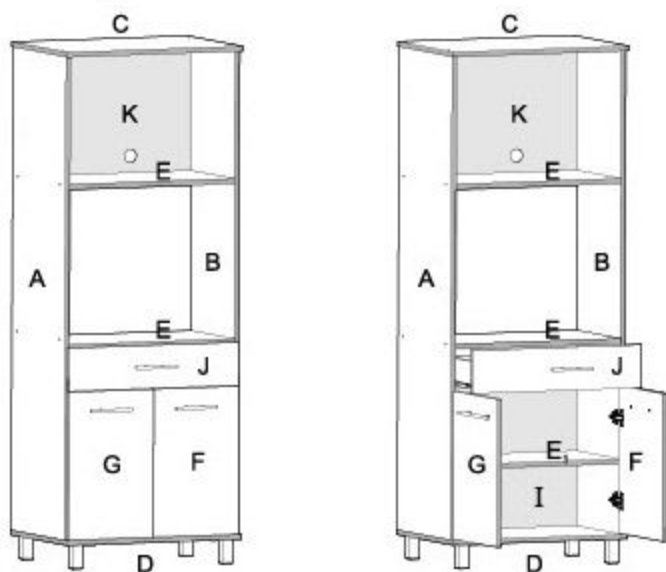









ארונית תנור בילט אין



מומלץ להניח את אריזת הקרטון על הרצפה ולהרכיב עליה את היחידה

מספר סידורי	1	2	3	4	5	6	7	8	9	10	11
שרטוט											
כמות	1	24+1	56	18	30	3+6	8	4	4+4	2+2	8
שם	מפתח אלן	דיבל עץ + דיבק	מסמרים 25X0.9	בורג אלן	בורג 16X3.5	ידיית בורג 22x4	בורג יורו למסילה	רגל אלומיניום	ותושבות צירים	סט מסילות למגירות	בורג כיסוי

1

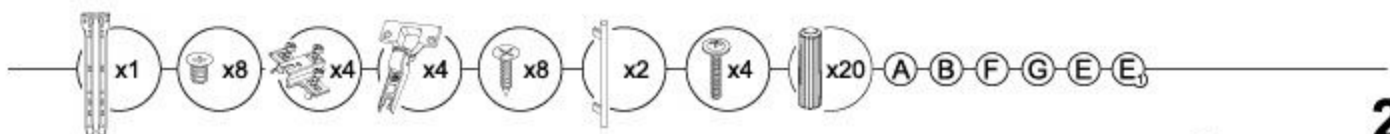
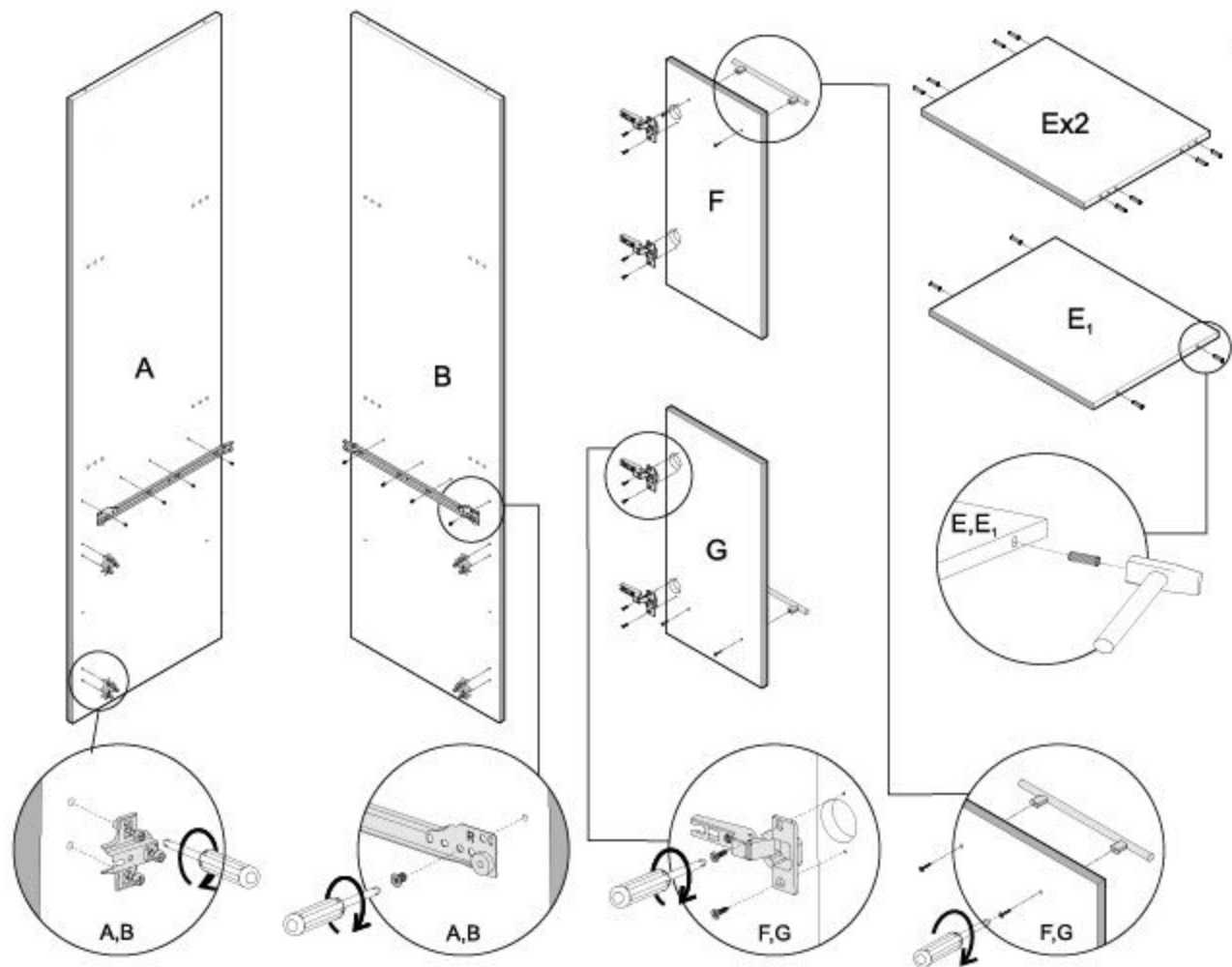

2

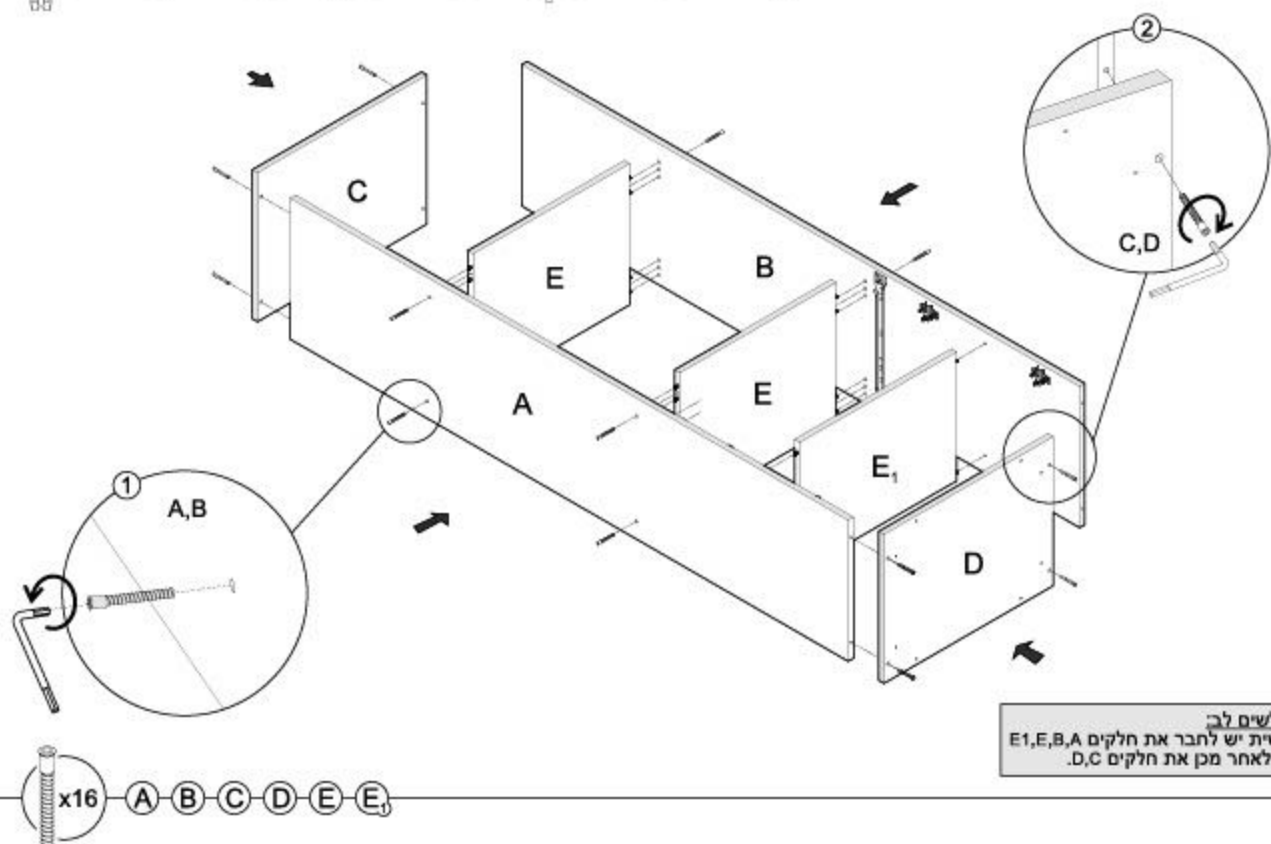

נא לשים לב
ראשית יש לחבר את חלקים A, B, E, E₁
ורק לאחר מכן את חלקים C, D.

x16 A B C D E E₁

3

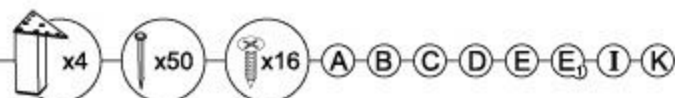
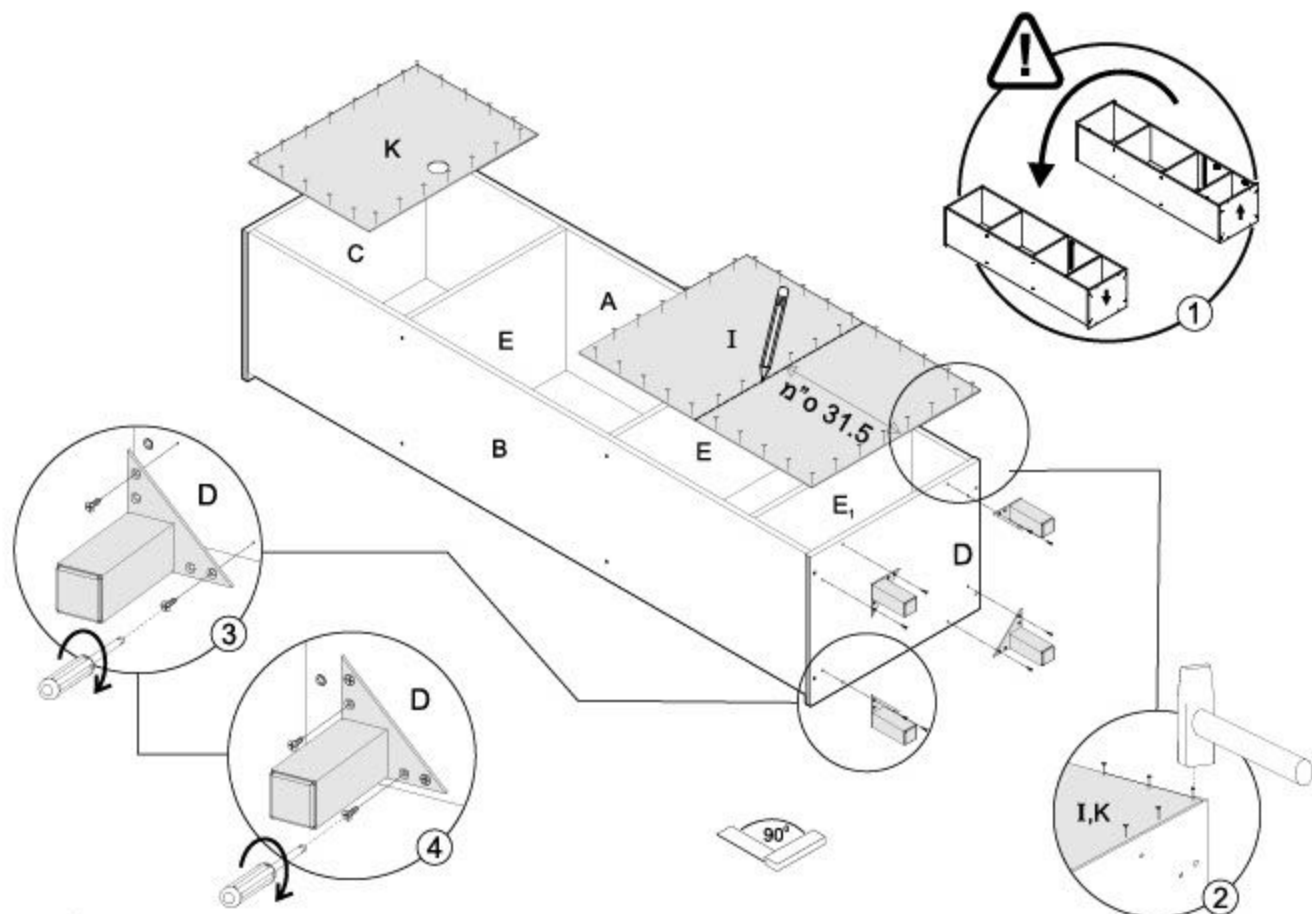

4

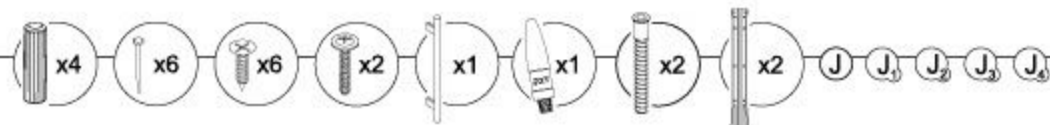
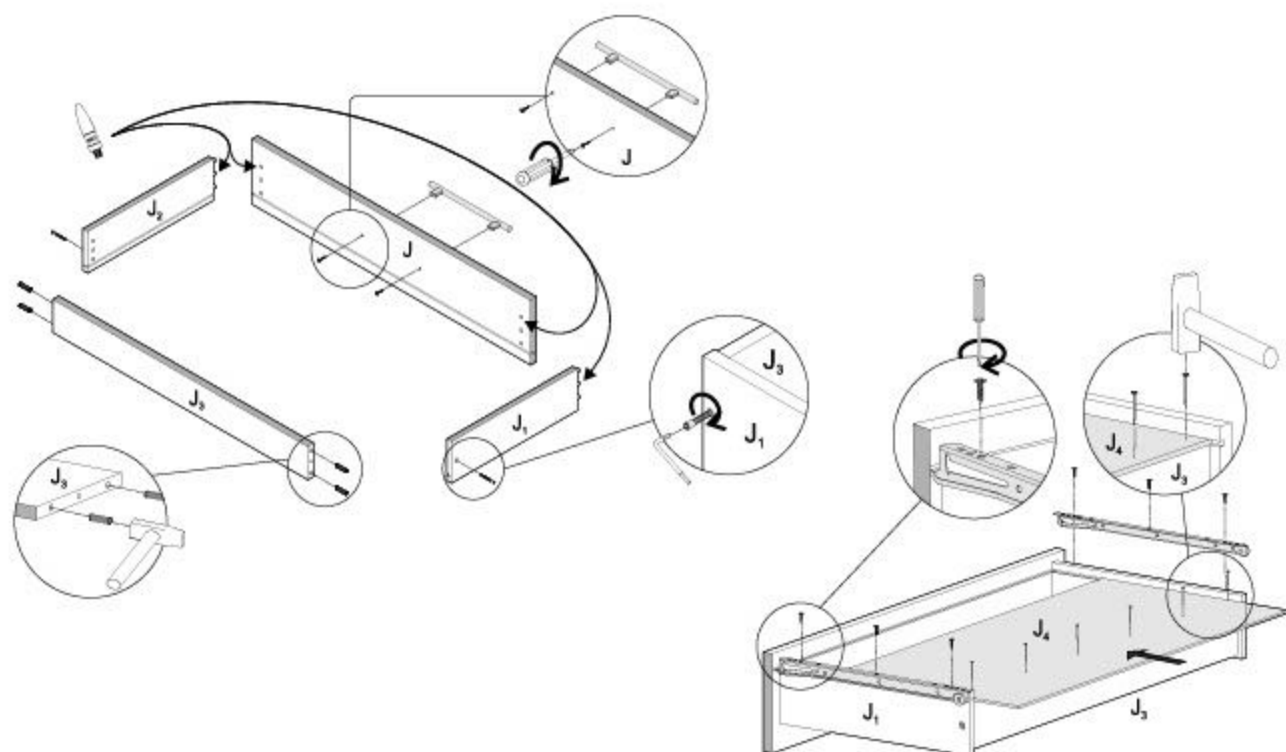

5

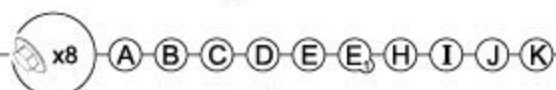
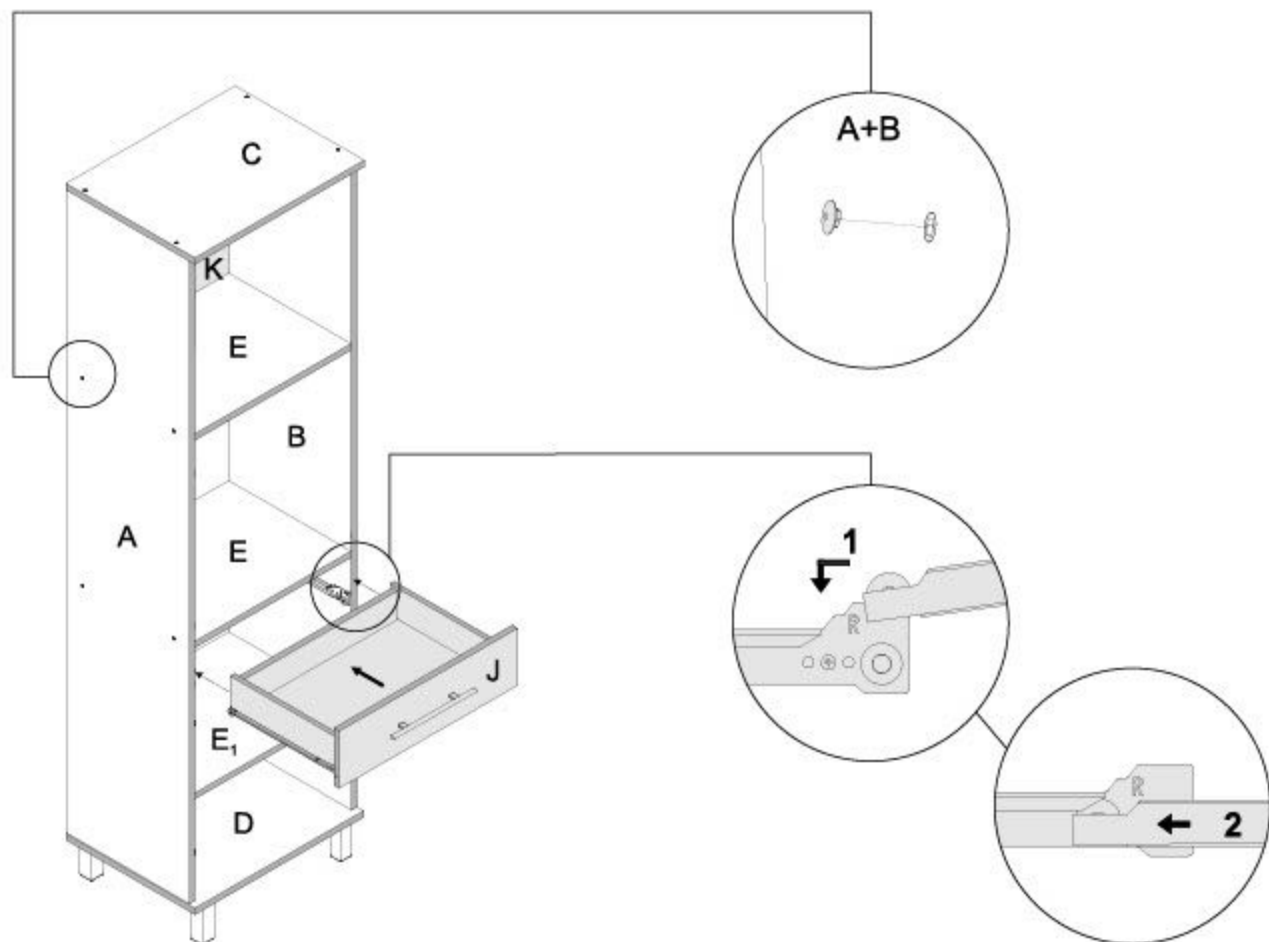

6

