

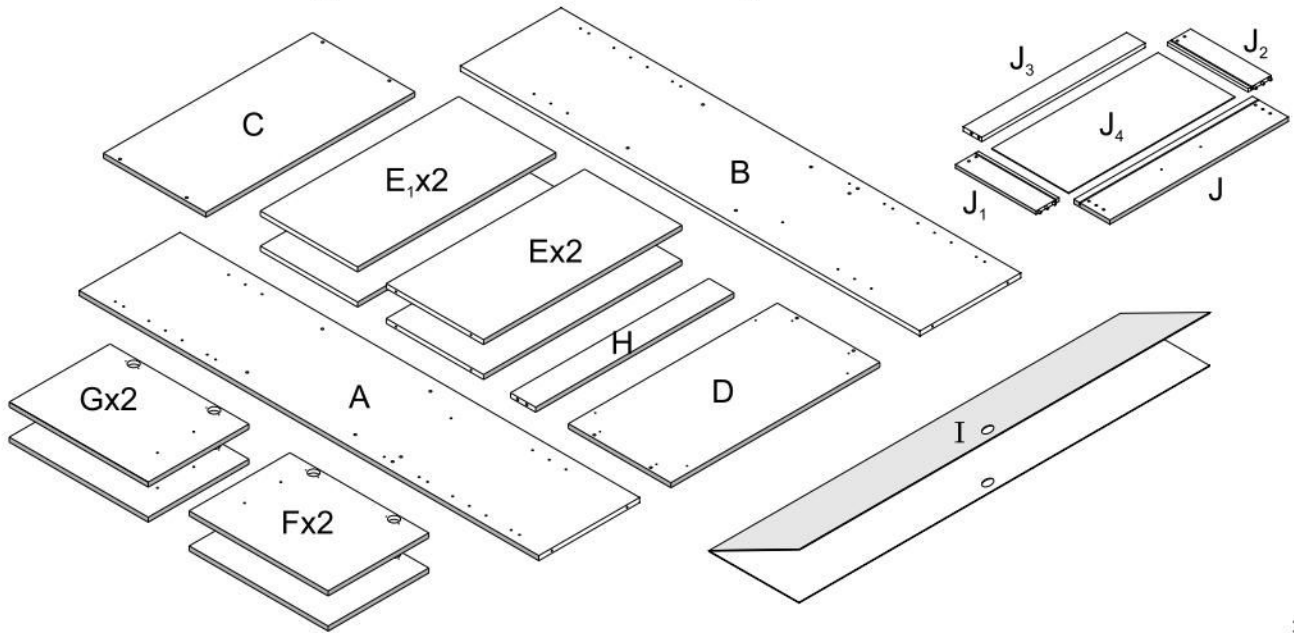

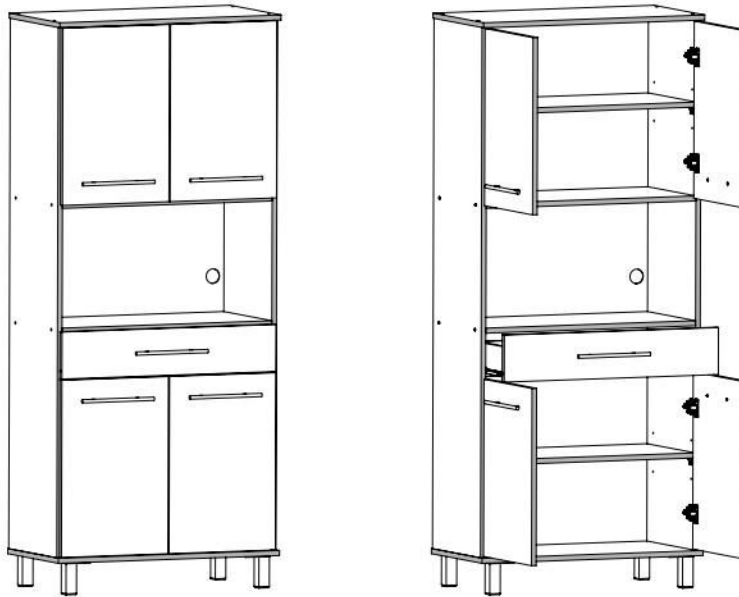









## 407 ארונית מיקרוגל



נא לשים לב:  
יחידת גב המזונית (I)  
מגיעה מקופלת.

מומלץ להניח את אריזת הקרטון על הרצפה ולהרכיב עליה את היחידה

מספר ידורי	1	2	3	4	5	6	7	8	9	10	11	12	
שרטוט													
כמות	1	8+1	90	16	36	5+10	4	8	4	8+8	2+2	8	
שם	מפתח אלן	דיבל עץ + דבק	מסמרים 25X0.9	בורג אלן	בורג 16X3.5	ידית + בורג 04X2	בורג למסילה	בורג יורו	תומך מדף	רגל אלומיניום	ותשבות צירים	מסילות לט למגירות	בורג כיסוי

1

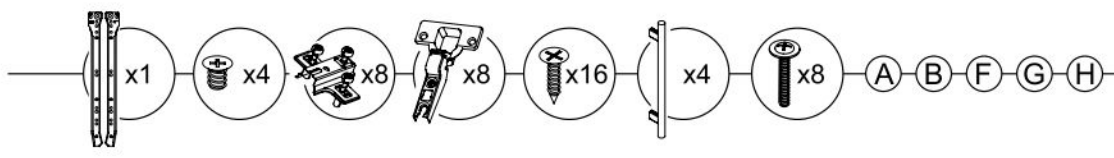
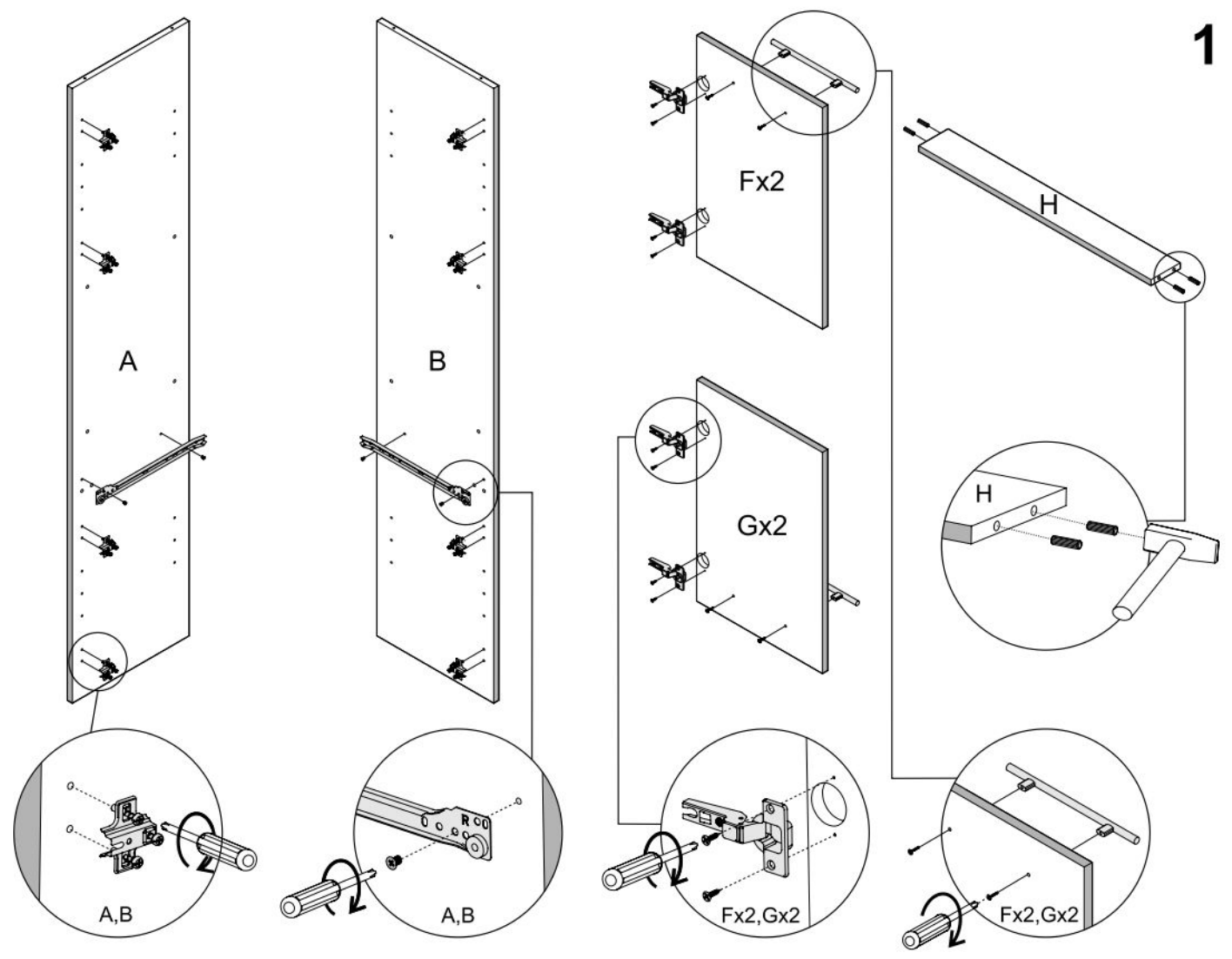



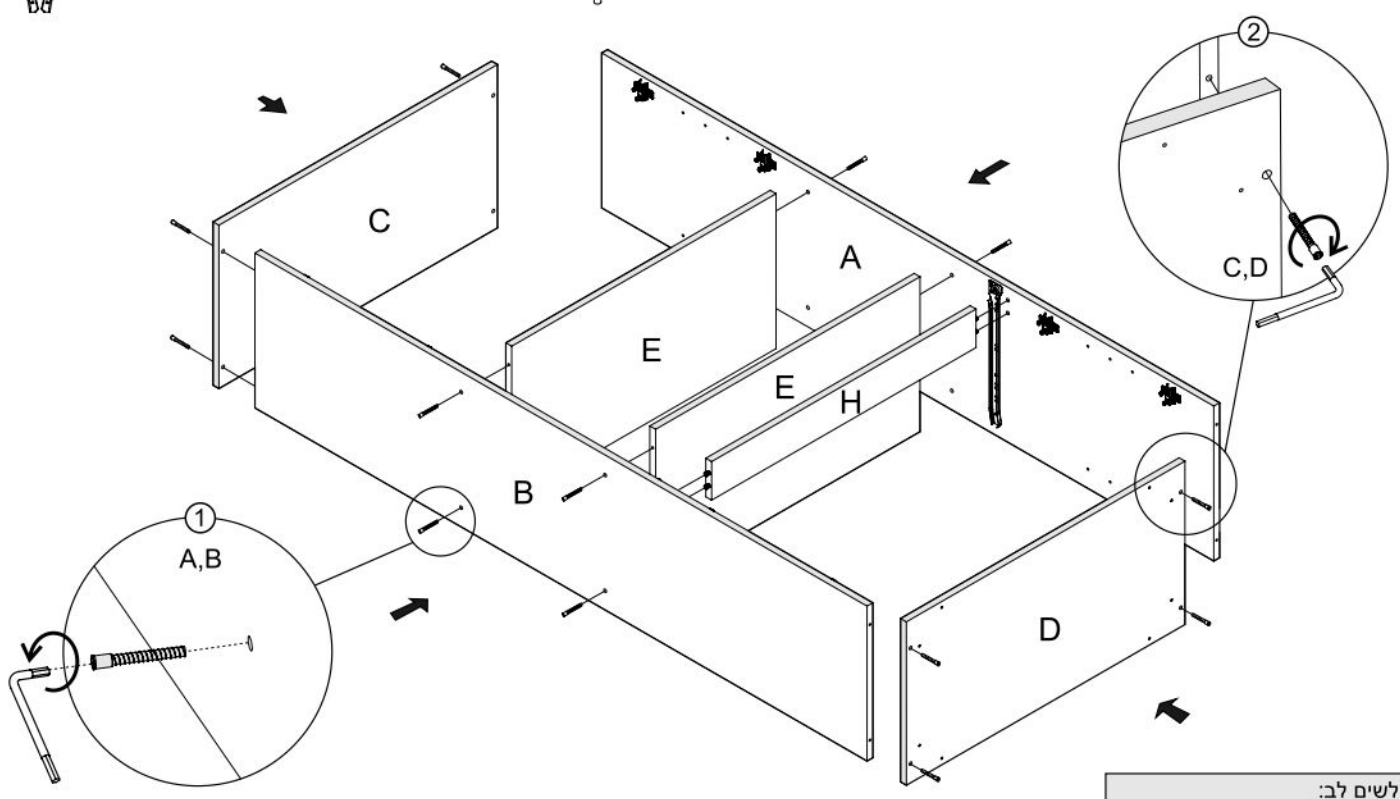

2

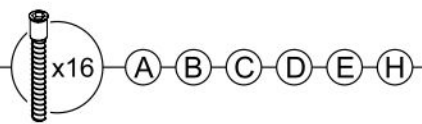

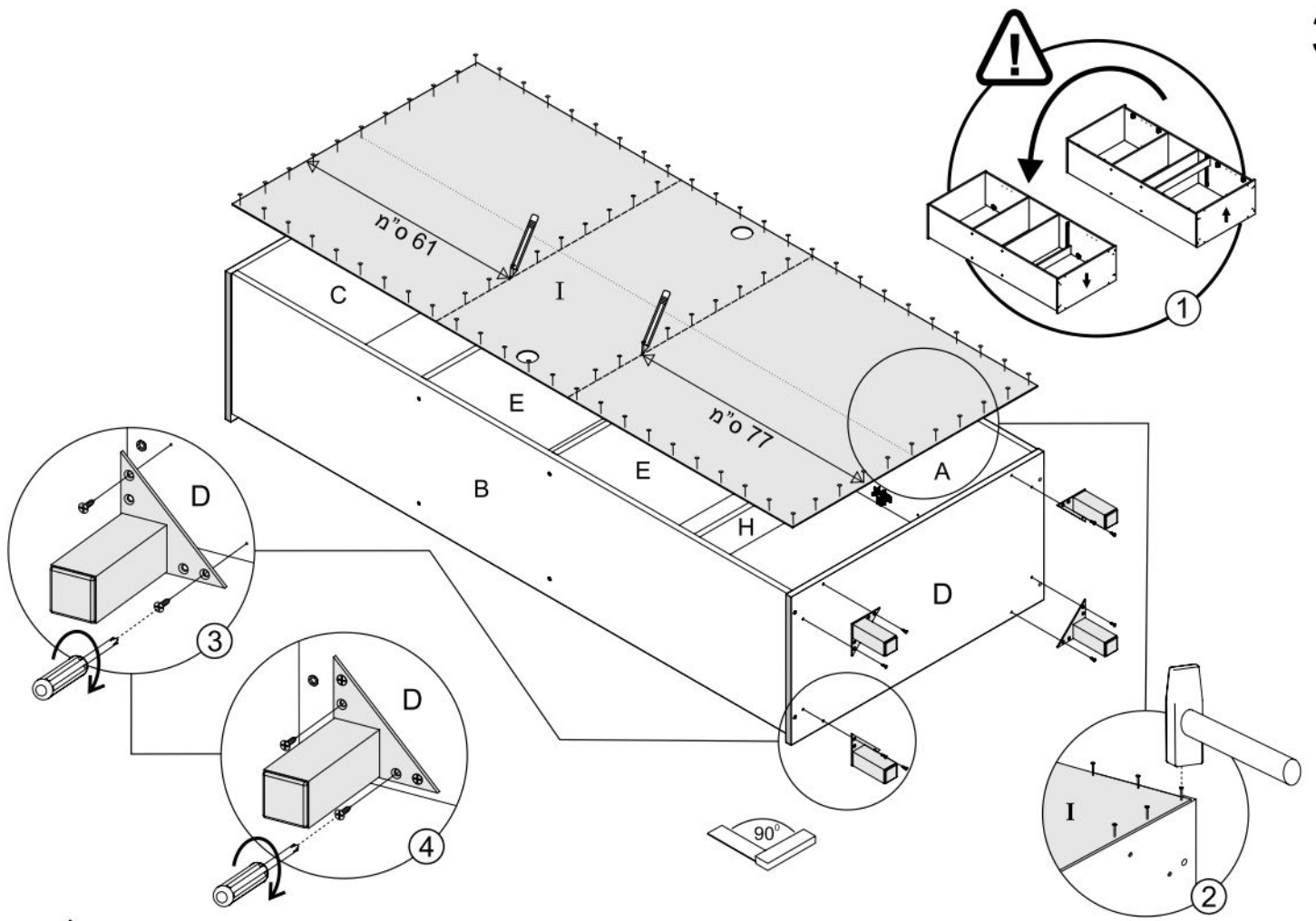





נא לשים לב:  
 ראשית יש לחבר את חלקים A, B, E, H.  
 ורק לאחר מכן את חלקים C, D.

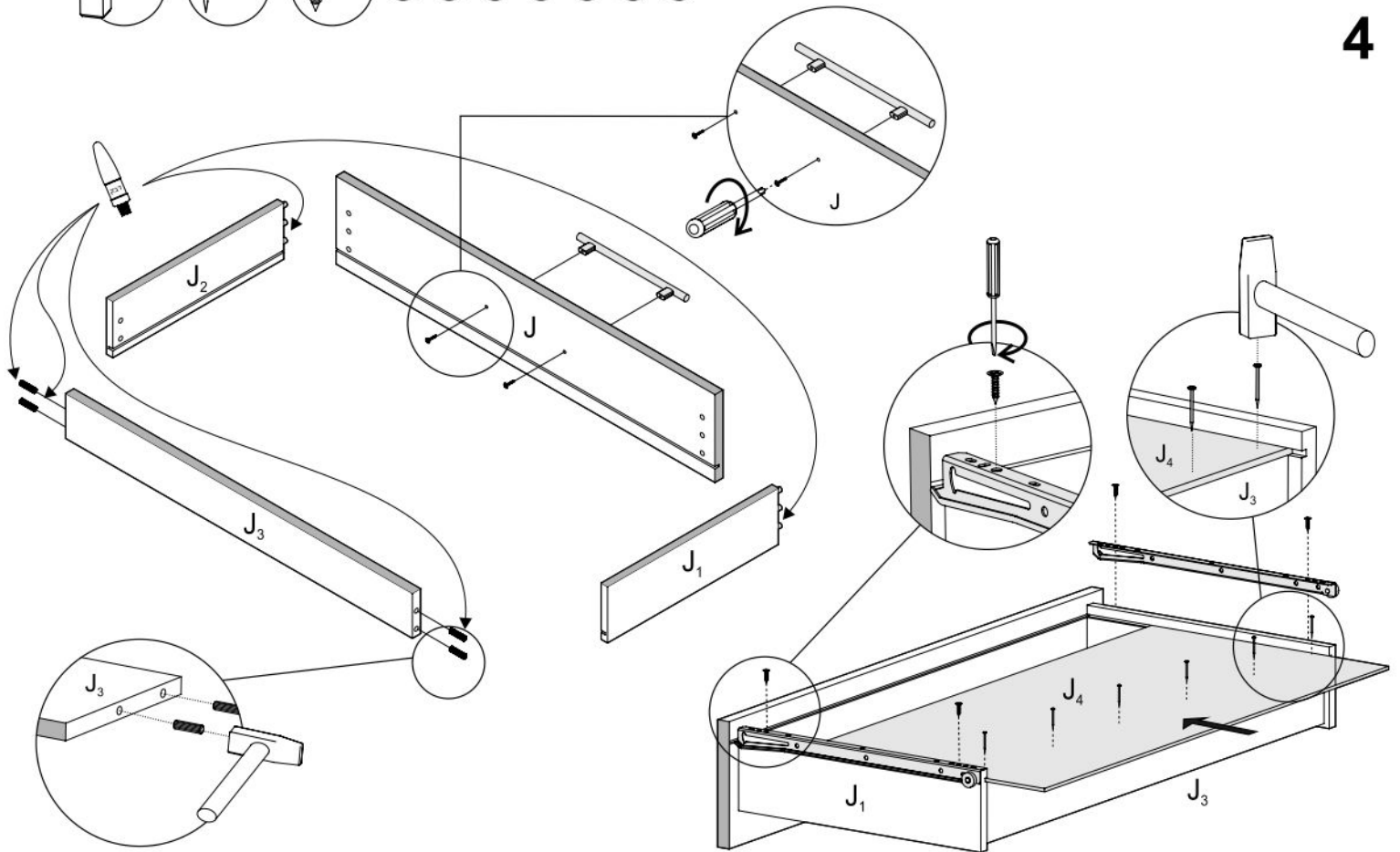



-  x4
-  x84
-  x16
- A
- B
- C
- D
- E
- H
- I



-  x4
-  x6
-  x4
-  x2
-  x1
-  x1
- J
- J<sub>1</sub>
- J<sub>2</sub>
- J<sub>3</sub>
- J<sub>4</sub>

